

Step Light 2122

4"x 3" (landscape orientation)
Recessed step or pathway light

Your path forward is important and Specialty is here to help guide your steps. Our fully dimmable solid state pathway or step light is intended for low level illumination in residential, institutional, commercial or theater applications. The 2122 light is wet location rated for recessed applications in cement, stone or drywall. You have found the datasheet and hope you enjoy the details.

PROJECT:

TYPE:

SPECIFIER:

DATE:

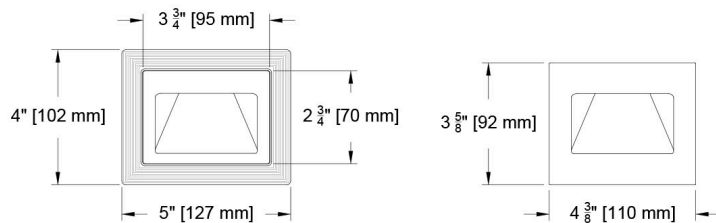
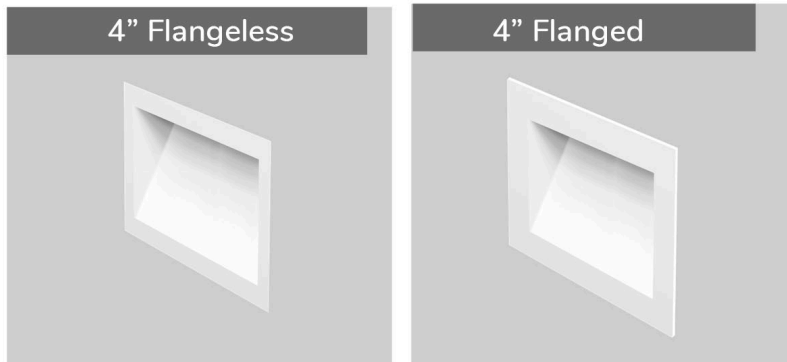

Key Points (2122)

Trim/Housing

- Flanged and flangeless installation
- 26 Anodize colors, 14 paint colors + Custom Color, RAL or wood available
- Milled aluminum trim
- IP54 Wet Location
- Handy Box housing supplied by others

Source/Optics

- Ambient Dim range 3000k to 1900k through dimming cycle
- Amber (1600k) available in 2 light outputs
- 2700k and 3000k (static white)
- 4 watt LED array in static white and Ambient Dim. 2 and 4 watt available in Amber.
- Up to 109 Delivered lumens
- <2 MacAdam Steps (<2SDCM) for static white.
- 90 + CRI (static white), 95 CRI (Ambient Dim)
- Integral, flat, veiling acrylic lens

Driver

- Universal 120-277v unless otherwise noted
- Flicker free to IEEE 1789-2015 available with EldoLED and Truphase™ selections
- Remote driver mounting required

Labels

- US, US tested to UL standards 1598, Wet location

Steplight 2122					
Source	CCT	System watts (W)	Delivered Lumens (Lm)	Lumens/Watt	10% Field
Specialty SG4	2700	4	102	26	120
Specialty SG4	3000	4	107	27	n/a
Specialty B4 (Amber)	1600	4	71	18	n/a
Specialty B2 (Amber)	1600	2	46	23	n/a

Measurements based on 2700K CCT

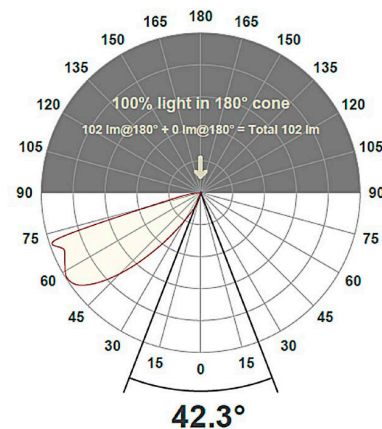

Step Light 2122

4"x 3" (landscape orientation)
Recessed step or pathway light

Ordering Codes

PROJECT: _____ SPECIFIER: _____
DATE: _____ TYPE: _____ QUANTITY: _____

Ordering Code Example: 2122-F-SG4-27-C1-P14

2122	TRIM	SOURCE / WATTS	CCT	DRIVER / CONTROL	TRIM FINISH
Step Light 2122	F Flanged Trim Z Flangeless Trim	SG4 4W 102Lm 90+CRI, 60+R9 Amber <hr/> B2 2W 46Lm 86+CRI, 32+R9 <hr/> B4 4W 71Lm 85+CRI, 38+R9 Ambient Dim™ <hr/> A4 5W 109Lm 95+CRI, 90+R9 3000k to 1900k	30 3000K 27 2700K Amber 1600K* Ambient Dim™ <hr/> AD 3000-1900K^ * Use with Amber (B2, B4) source selection ^ Use with Ambient Dim (A3) source selection	C1 0-10 1.0%, UNV (120V) linear C24 UNV (120-277V) C24/C1 *24V Constant Voltage C2 ELV/Triac 1.0%, (120-277V) linear E1 0-10 0.1%, UNV (120-277V) log E2 DALI-2 0.1%, UNV (120-277V) log E3 0-10 0.1%, UNV (120-277V) linear TR2 TruPhase™ 0.1%, (120-120V) log Up to 20W Forward and Reverse compatible Phase Dimming Static White & Ambient Dim only Note: Remote mounting required for all drivers Some Lutron Drivers available at 4 watts. Consult factory.	W White Paint A01 Black Anodize D Wood** C Custom/RAL Color* AXX Specialty anodize color* PXX Specialty Paint Color* * Refer to Specialty Finish Guide ** Refer to Specialty Wood Trim Guide



Wall Cutouts & Dimensions

Steplight (Handy Box)

Flangeless Trim (Z)

(2122-Z-SG4-)

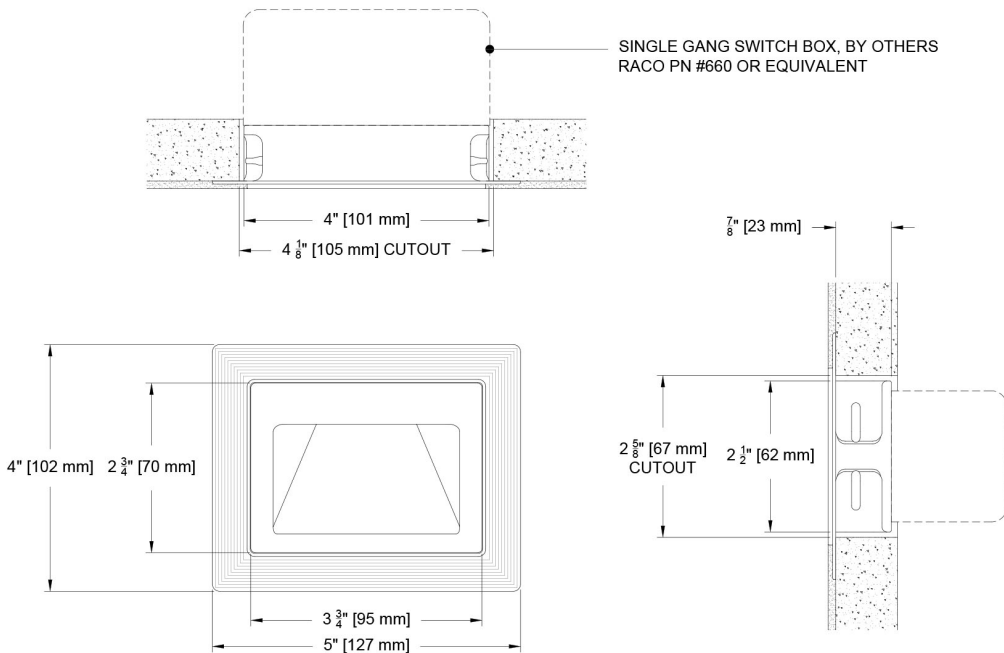

Steplight (Handy Box)

Flanged Trim (F)

(2122-F-B2-)

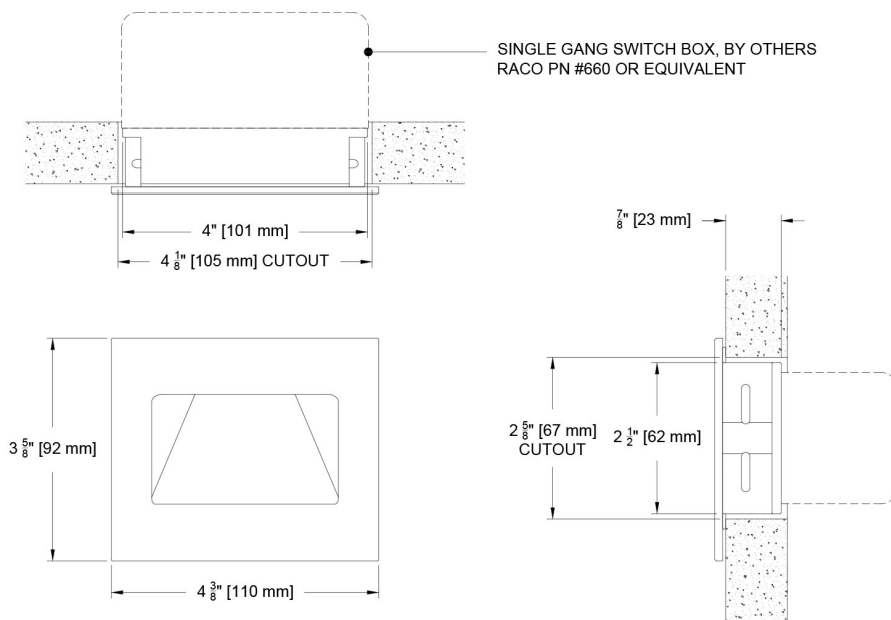

Wall Cutouts & Dimensions

Driver Enclosure for C1, C2

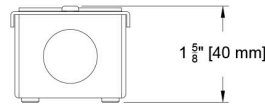
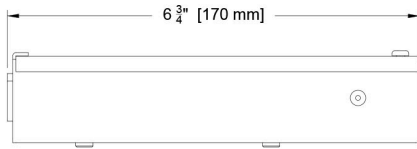

Driver Enclosure for E1, E2, E3

